











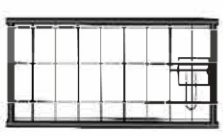
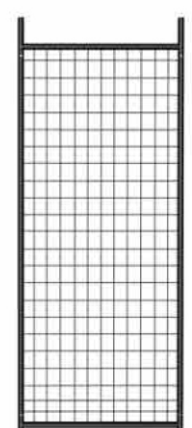
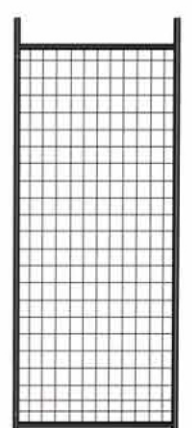











SOBKY TYP 2

A*1			B*3	C*4
				
A-1*1	A-2*1	A-3*1		
D*3		E*2	N*1	W*2
				
D-1*3	D-2*3			

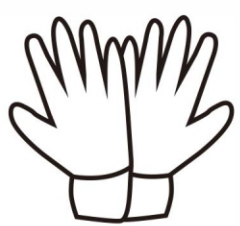
F1*35	F2*2	F3*4	F4*4	K*2	H*32
					
F1-1*35	F2-1*2	F3-1*4		K	H
					
F1-2*35	F2-2*2	F3-2*4			
M*1	P*1	J*8	I*12		
					

1.

1-①

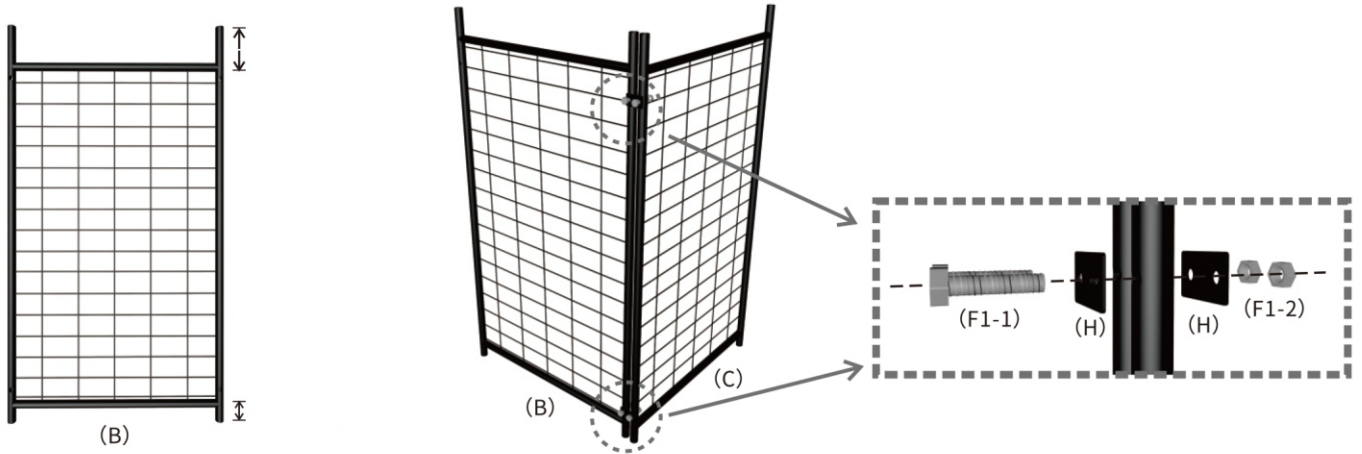

1-②

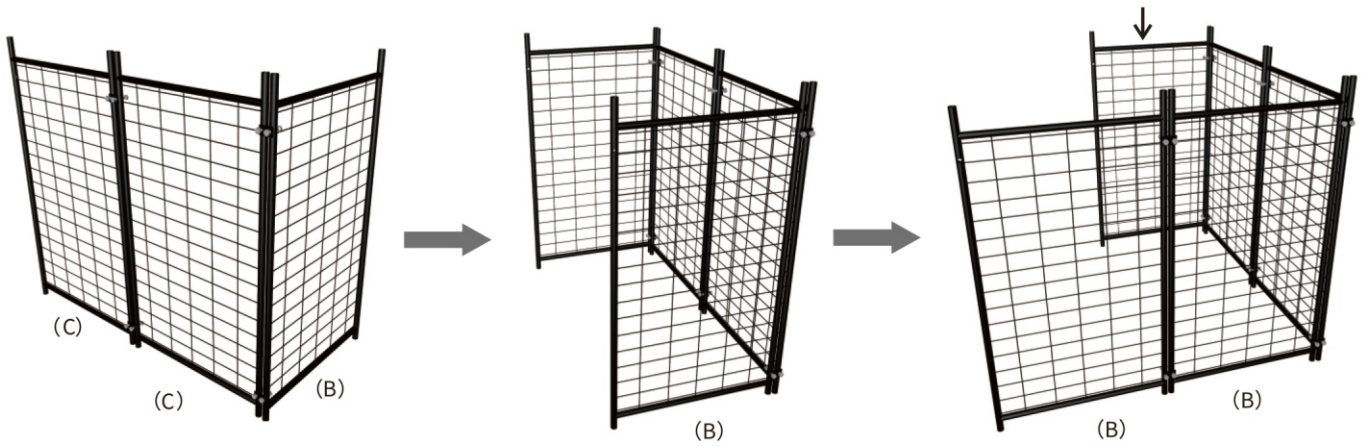

1-③

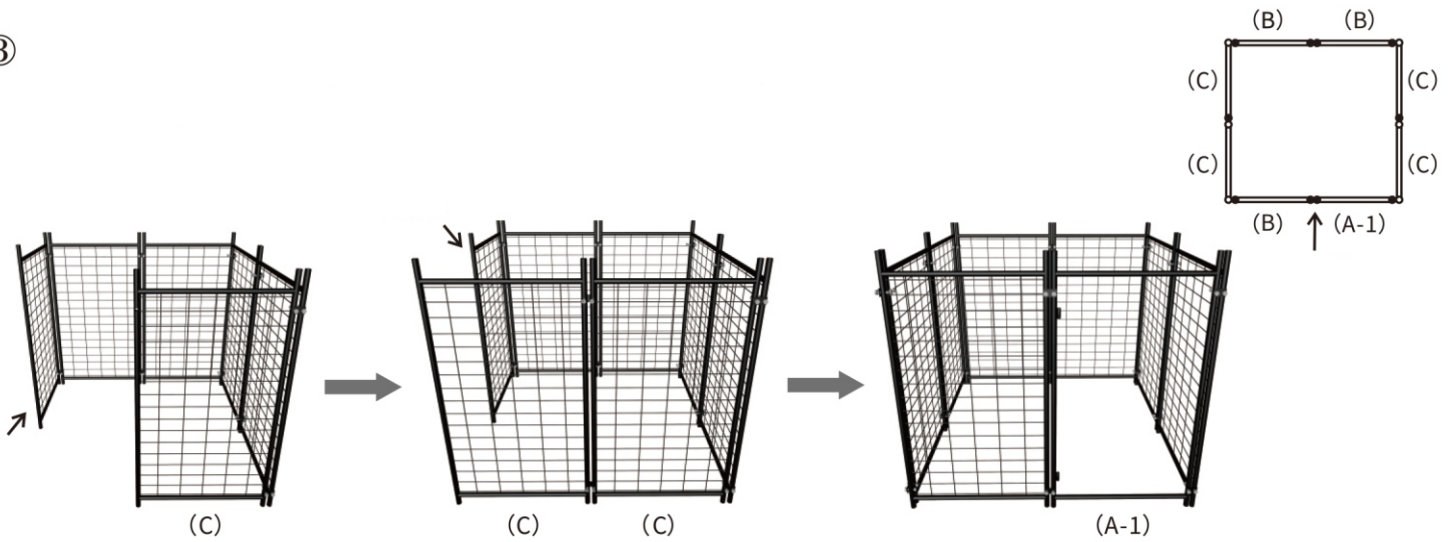

2.

2-①

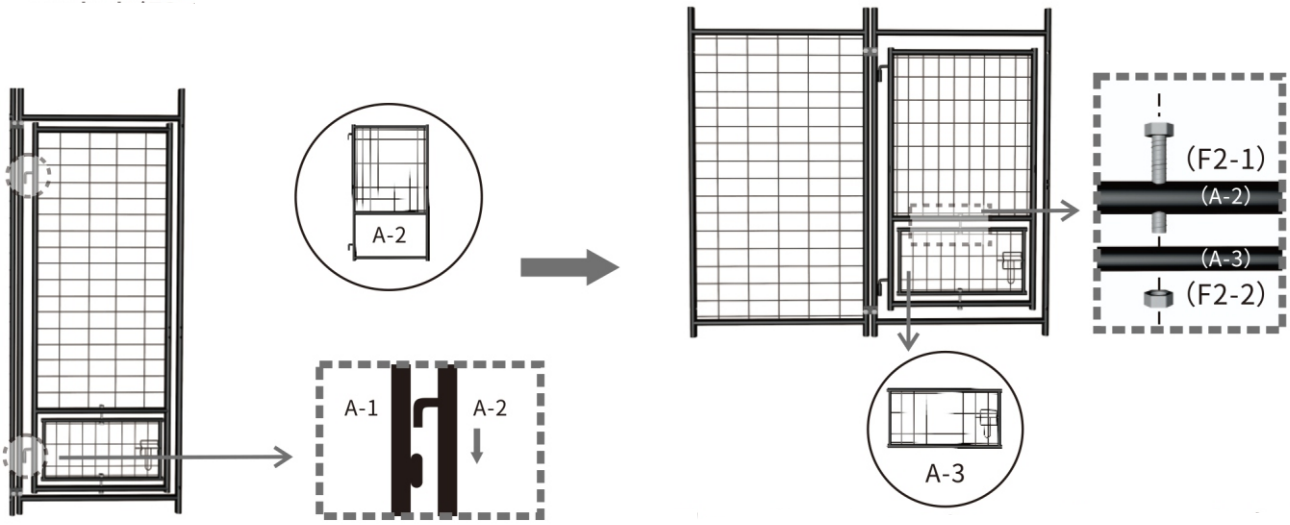

2-②

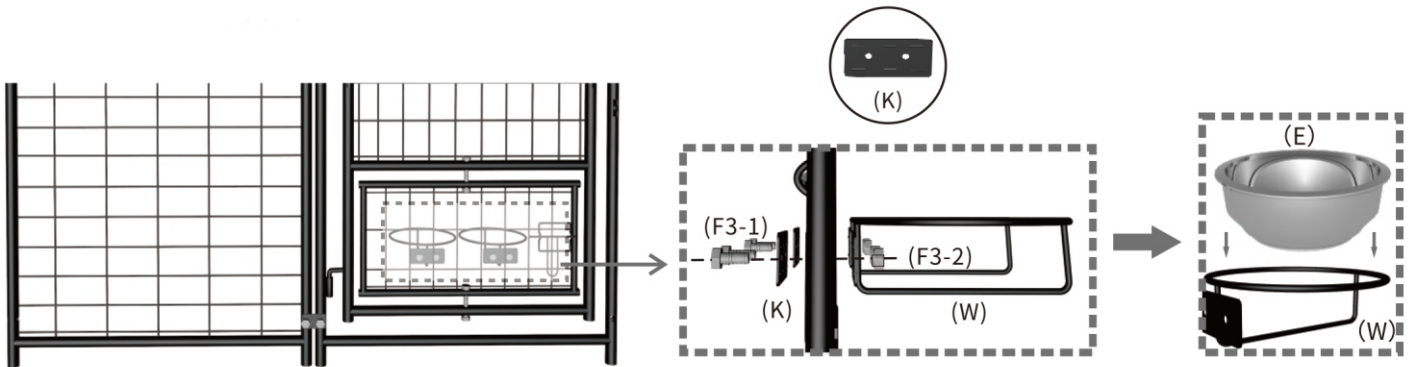

2-③

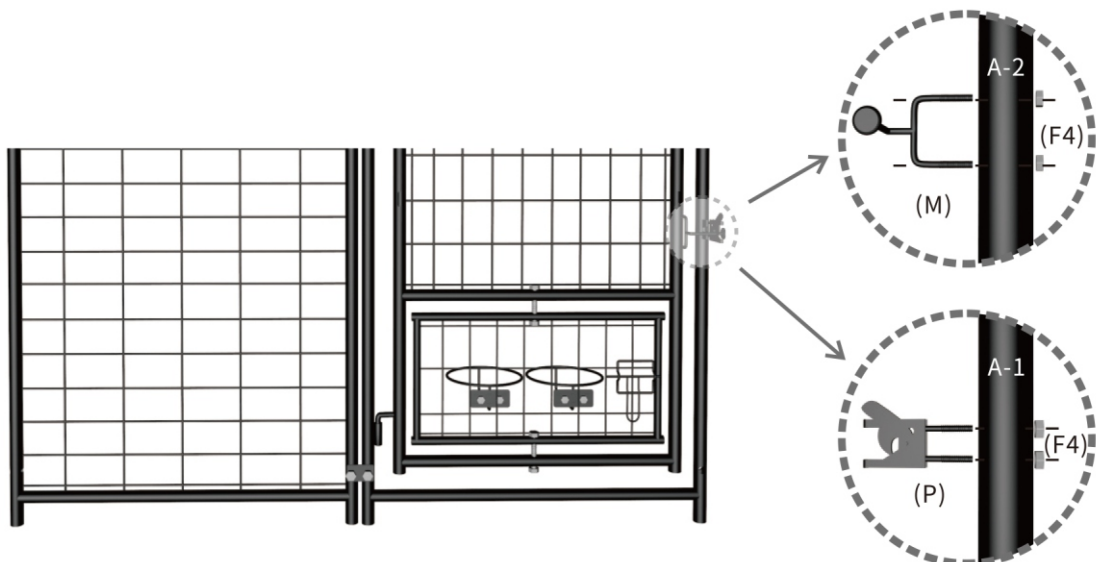

2-④

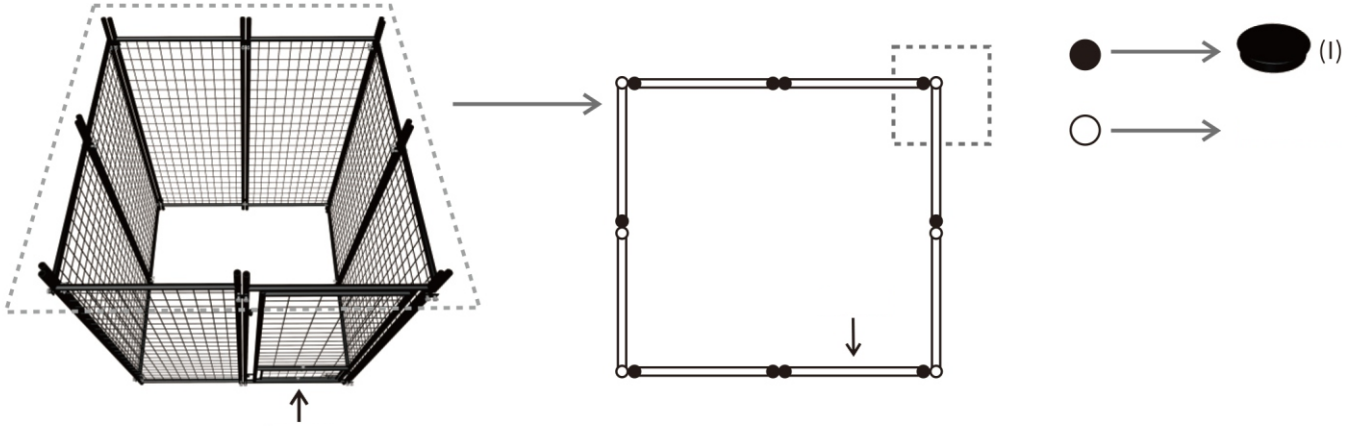

3.

3-①

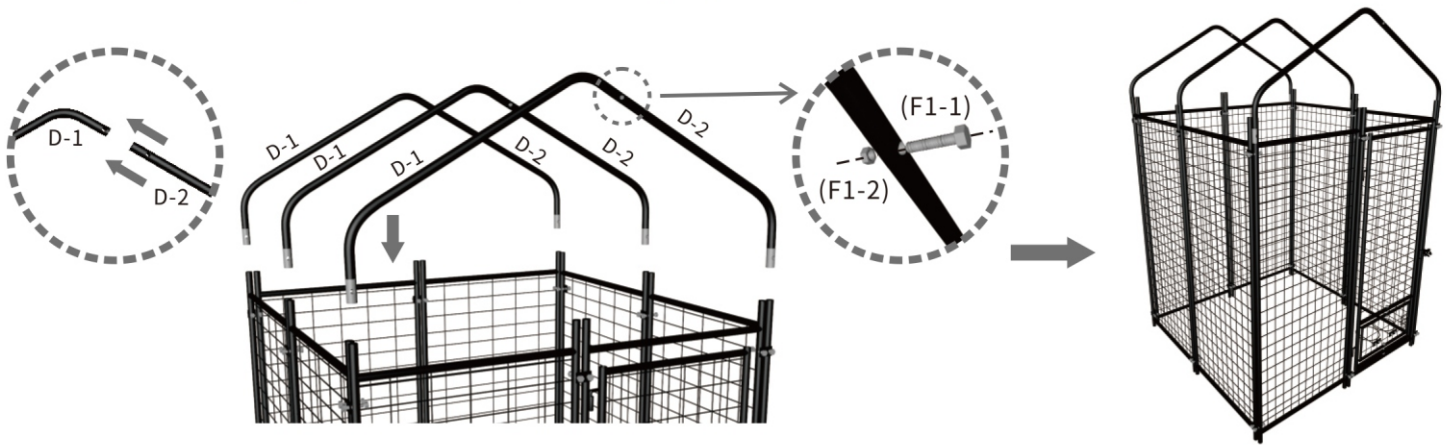

3-②

